

COMPANY PROFILE



PRIMA

PT. MAHKOTA PRIMA

LOW VOLTAGE & MEDIUM VOLTAGE
ELECTRICAL SWITCHBOARD MANUFACTURER



Office and Workshop:

Jl. Veteran No.18, Kp. Cisereh, RT 002 RW 06, Ds. Kadujaya

Kec. Curug, Kab. Tangerang 15810

Telp : 021-5983497, 5983498

Facs : 021-5983496

Email : mprima@centrin.net.id

KATA PENGANTAR

PT. MAHKOTA PRIMA didirikan pada tahun 2005 bergerak dalam bidang produksi panel listrik tegangan rendah (up to 690V) dan tegangan menengah (up to 24 kV).

PT. MAHKOTA PRIMA pada tahun 2009 telah bekerja sama dengan *GE Consumer & Industrial* untuk memproduksi dan memasarkan **GE SenPlus** (MCC Low Voltage up to 690 VAC), **SecoGear** (Metal Clad Switchgear 3.3-27kV, Air Insulated).

PT. MAHKOTA PRIMA selalu memberikan prioritas utama pada kualitas produk dan ketepatan jadwal pengiriman, oleh sebab itu setiap panel yang kami produksi akan melewati kontrol kualitas yang sangat ketat, sesuai dengan standard yang dibutuhkan dalam era globalisasi ini. Hal ini kami lakukan supaya kami dapat memastikan bahwa pelanggan kami akan selalu mendapatkan pelayanan terbaik dari kami, untuk bersama-sama dalam program pembangunan konstruksi.

Slogan kami: **QCDS**.

Q itu **Quality** artinya setiap produk dari kami senantiasa dalam kondisi kualitas terbaik sesuai standard.

C itu **Cost** artinya harga dari produk kami senantiasa bersaing dan kompetitif dengan tidak melupakan kualitas.

D itu **Delivery** artinya produk kami senantiasa di proses dengan memperhitungkan dari tanggal pengiriman yang tepat, sehingga Pelanggan kami mendapatkan kepuasan. Dan yang terakhir

S itu **Safety** artinya produk kami senantiasa mengutamakan keselamatan penggunaannya.

Penghargaan buat kami untuk kerja sama dan kepercayaan yang diberikan, untuk itu kami ucapkan banyak Terima kasih.

Direktur

Paulus

DAFTAR ISI :





1. INFORMASI UMUM
2. CHART STRUKTUR ORGANISASI
3. GAMBARAN UMUM
4. SCOPE PRODUKSI
5. FASILITAS KAMI
6. REFERENSI PROYEK

1. INFORMASI UMUM

1. Nama : PT. MAHKOTA PRIMA
2. Alamat Kantor & Workshop :
 Jl. Veteran No.18 Kp. Cisereh RT 002 RW 06
 Ds. Kadujaya Kec. Curug Kab. Tangerang 15810
 Telp : (62-21) 5983497
 Fax : (62-21) 5983496
 E-mail Address : mprima@centrin.net.id
3. N.P.W.P : 02.475.749.4-451.000
4. Direktur : Paulus
5. Karyawan :

Manager	: 03 Persons
Ass. Manager	: 02 Persons
Supervisor	: 03 Persons
Engineer + Designer	: 14 Persons
QC (Inspector)	: 06 Persons
Operator + Teknisi	: 19 Persons
Team Sales	: 02 Persons
Staffs	: 06 Persons
Total	: 55 Persons
6. Jenis Usaha

PT. MAHKOTA PRIMA merupakan perusahaan yang bergerak dalam bidang perakitan dan penjualan panel-panel listrik, baik listrik tegangan rendah maupun tegangan menengah yang meliputi::

 -  Low & Medium Voltage Switchgear
 -  Low & Medium Voltage Motor Control Center
 -  Low & Medium Voltage Capacitor Bank
 -  Automatic Transfer Switch
 -  Synchronizing Genset Panel

12-24kV Metal Clad SwitchGear



Current issue date: 15 November 2019
Expiry date: 20 October 2022
Certificate identity number: 10231098

Original approval(s):
ISO 9001 - 21 October 2013

Certificate of Approval

This is to certify that the Management System of:

PT Mahkota Prima

Jl. Veteran Kp. Cisereh 18 RT 002/06,, Desa Kadujaya, Kec. Curug, Tangerang, Banten, Indonesia

has been approved by Lloyd's Register to the following standards:

ISO 9001:2015

Approval number(s): ISO 9001 – 0044564

The scope of this approval is applicable to:

Assembly of Low Voltage (LV) and Medium Voltage (MV) Electrical Switch Board.



Luis Cunha

Area Operations Manager - SAMEA

Issued by: PT. Lloyd's Register Indonesia

for and on behalf of: Lloyd's Register Quality Assurance Limited



001

Lloyd's Register Group Limited, its affiliates and subsidiaries, including Lloyd's Register Quality Assurance Limited (LRQA), and their respective officers, employees or agents are, individually and collectively, referred to in this clause as 'Lloyd's Register'. Lloyd's Register assumes no responsibility and shall not be liable to any person for any loss, damage or expense caused by reliance on the information or advice in this document or howsoever provided, unless that person has signed a contract with the relevant Lloyd's Register entity for the provision of this information or advice and in that case any responsibility or liability is exclusively on the terms and conditions set out in that contract. Issued by: PT. Lloyd's Register Indonesia, LRQA Indonesia, Dea Tower 1 12th Floor, Kawasan Mega Kuningan, Jl. Mega Kuningan Barat IX Kav. E4.3 No.1, Jakarta 12950, Indonesia for and on behalf of: Lloyd's Register Quality Assurance Limited, 1 Trinity Park, Bickenhill Lane, Birmingham B37 7ES, United Kingdom





Certificate of Approval

This is to certify that the Management System of:

PT Mahkota Prima

Jl. Veteran Kp. Cisereh 18 RT 002/06, Desa Kadujaya, Kec. Curug, Tangerang, Banten, Indonesia

has been approved by LRQA to the following standards:

OHSAS 18001:2007



Basem Obaid - Area Operations Manager

Issued By: PT. Lloyd's Register Indonesia

for and on behalf of: Lloyd's Register Quality Assurance Limited

Current Issue Date: 14 May 2018
Expiry Date: 1 March 2021
Certificate Identity Number: 10081889

Original Approvals:
OHSAS 18001 – 2 March 2015

Approval Number(s): OHSAS 18001 – 0049125

The scope of this approval is applicable to:
Assembly of Low Voltage (LV) and Medium Voltage (MV) Electrical Switch Board.



001

Lloyd's Register Group Limited, its affiliates and subsidiaries, including Lloyd's Register Quality Assurance Limited (LRQA), and their respective officers, employees or agents are, individually and collectively, referred to in this clause as 'Lloyd's Register'. Lloyd's Register assumes no responsibility and shall not be liable to any person for any loss, damage or expense caused by reliance on the information or advice in this document or howsoever provided, unless that person has signed a contract with the relevant Lloyd's Register entity for the provision of this information or advice and in that case any responsibility or liability is exclusively on the terms and conditions set out in that contract.
Issued By: PT. Lloyd's Register Indonesia, LRQA Indonesia, Dea Tower 1 12th Floor, Kawasan Mega Kuningan, Jl. Mega Kuningan Barat IX Kav. E4.3 No.1, Jakarta 12550, Indonesia for and on behalf of: Lloyd's Register Quality Assurance Limited, 1 Trinity Park, Bickenhill Lane, Birmingham B37 7ES, United Kingdom

PURCHASE AGREEMENT

BETWEEN

TOSHIBA INDUSTRIAL PRODUCTS AND SYSTEMS CORPORATION

AND

PT.MAHKOTA PRIMA

DATE: July 10 , 2018

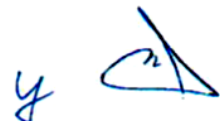

Purchase Agreement

THIS AGREEMENT made and entered into this *10th* day of *July*, 2018 by and between TOSHIBA INDUSTRIAL PRODUCTS AND SYSTEMS CORPORATION, a corporation of Japan with its principal place of business at 580, Horikawa-cho, Saiwai-ku, Kawasaki-shi, Kanagawa-ken, Japan (hereinafter called "TIPS") and PT.MAHKOTA PRIMA, having its principal place of business at JL.Veteran No.18, Kp.Cisereh RT.002 RW. 06 Ds. Kadujaya Kec. Curug-Kab. Tangerang, Indonesia (hereinafter called "MP")

WITNESSETH:

WHEREAS, MP is engaged in the manufacture and sale of Products as hereinafter defined and is desirous of sale to TIPS;

WHEREAS, TIPS is willing to purchase Products from MP;

WHEREAS, the parties deem it desirable to establish terms and conditions which shall govern MP's manufacture and sale of Products and TIPS's purchase of Products.

NOW THEREFORE, the parties hereby agree as follows:

1. Products

The term "Products" as used herein means Motor Control Center and Low Voltage Switch Gear which shall be listed in ANNEX 1 .

2. Orders

(1) All purchase orders (hereinafter called P.O.) to be placed by TIPS shall be in writing, and shall also indicate prices, quantities, shipping schedules, packing requirements and other terms of purchase of Products.

(2) All P.O. to be placed by TIPS with MP under THIS AGREEMENT shall be deemed to be accepted if MP;

(a) sign P.O. and return a copy of P.O.,

(b) return MP's own form of acknowledgement of P.O. or

(c) inform TIPS that MP commences the manufacture of Products as ordered.

Notwithstanding the above, any terms or conditions stated by MP in any prior proposal or in acknowledging or otherwise accepting P.O. shall not bind TIPS unless specifically accepted by TIPS in writing.

3. Price and Payment

(1) The price of Products shall be indicated in US Dollar, Japanese Yen and Rupiah and shall be on the basis of FOB INDONESIA PORT or FCA INDONESIA AIRPORT which shall be construed according to INCOTERMS 2010.

(2) Payment by TIPS to MP for each accepted P.O shall be made in US Dollar , Japanese Yen and Rupiah by means of a telegraphic transfer remittance within forty five (45) days after receipt of MP's shipping documents.



connection therewith.

27. Amendment

THIS AGREEMENT may be amended only by a written instrument signed by duly authorized officers of representatives of both parties.

28. Governing law

THIS AGREEMENT and any accepted purchase order shall be governed by and construed and interpreted in accordance with the laws of Japan.

IN WITNESS WHEREOF, the parties hereto have caused THIS AGREEMENT to be executed by their respective duly authorized representatives as of the day and year first above written.

TOSHIBA INDUSTRIAL PRODUCTS
AND SYSTEMS CORPORATION

PT.MAHKOTA PRIMA



BY S. Yamamoto
NAME: SATOSHI YAMAMOTO

BY _____
NAME: PAULUS

TITLE: Director

TITLE: President Director



—
INDONESIA

Certificate of acknowledgement System Pro-E Power Partner

PT. Mahkota Prima

is authorized to project, manufacture and sell switchboard on its own responsibility by using ABB components and according to the relevant ABB manuals as well as the standard IEC 61439-1-2 up to 6300 A.

This certificate is valid from the signing date until December 31, 2020.



Alfando Lumbanraja
Sales Manager
Electrification
PT ABB Sakti Industri, Indonesia

2. ORGANIZATION CHART

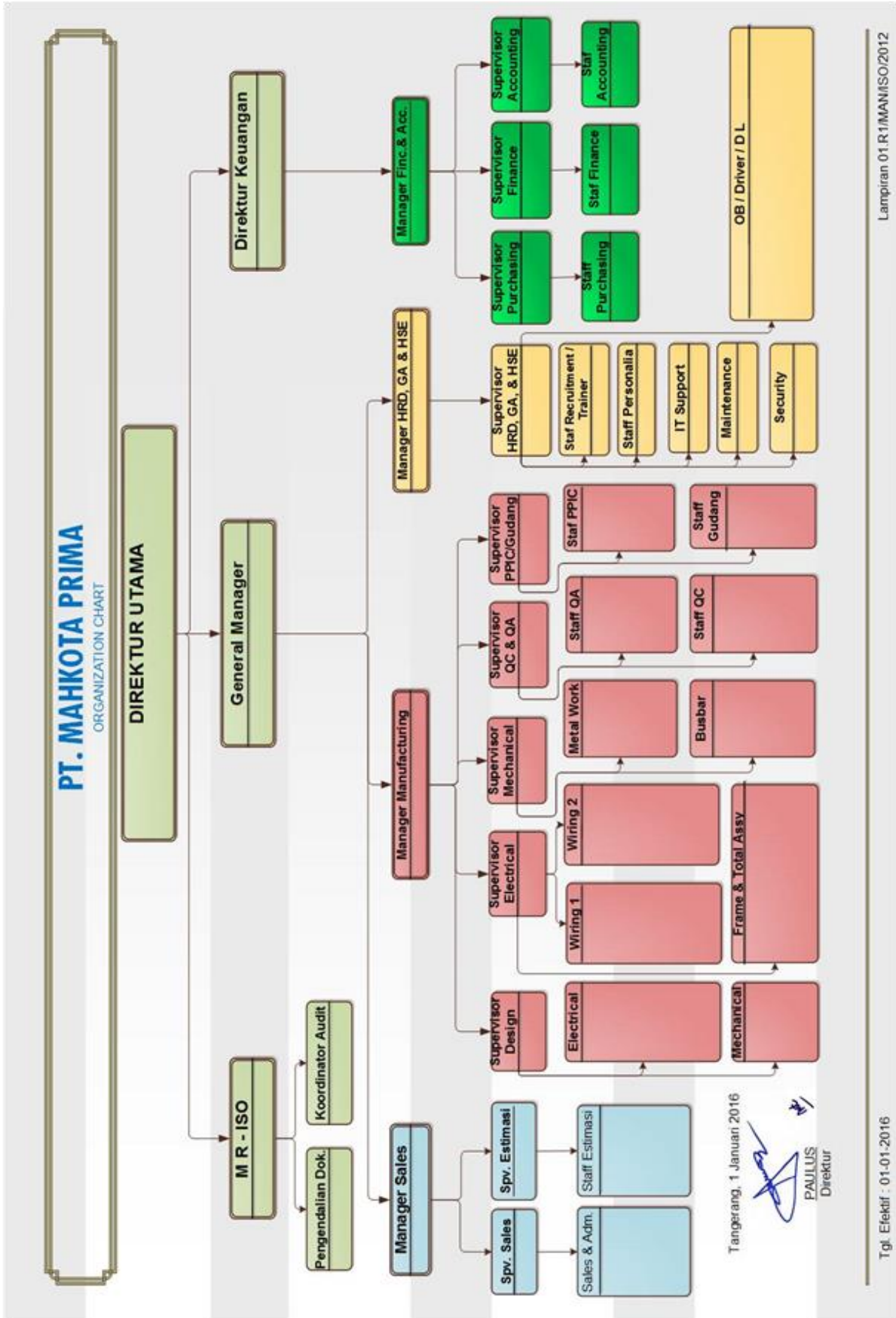

CONTROL PLAN

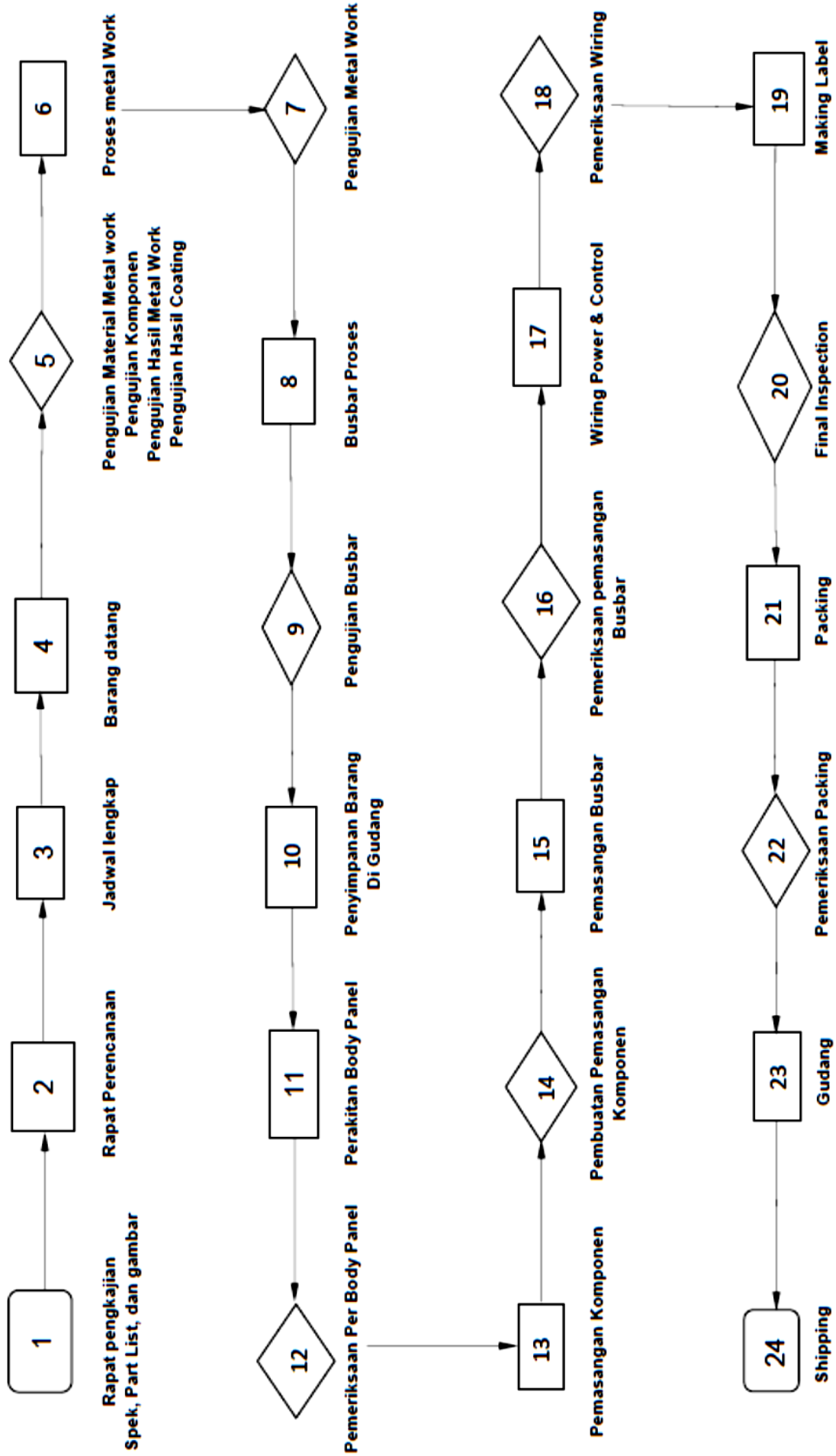

3. GAMBARAN UMUM

TAMPAK LUAR PABRIK PT. MAHKOTA PRIMA



SUASANA DALAM PABRIK PT MAHKOTA PRIMA



GE SENPlus 400V Motor Control Center Fully Drawout Type



GE SENPlus 400V Motor Control Center Fully Drawout Type



400V Switchgears , Auto Transfer Switch (ATS)



400V Motor Control Center Modular Fixed type



400V Switchgears , Auto Synchronizing Generator, Auto Transfer Switch (ATS) and Capacitor Bank



3.3kV Switchgears , Motor Control Center , Capacitor Bank



4. SCOPE PRODUKSI

Switchgears

✚ Medium Voltage Switchgear

- Metal Enclosed Switchgears up to 24kV, 2000A, 25kA
- Metal Clad Switchgear up to 24kV, 2000A, 25kA



✚ Low Voltage Switchgear

- Metal Enclosed Switchgears up to 600V, 6300A, 70kA

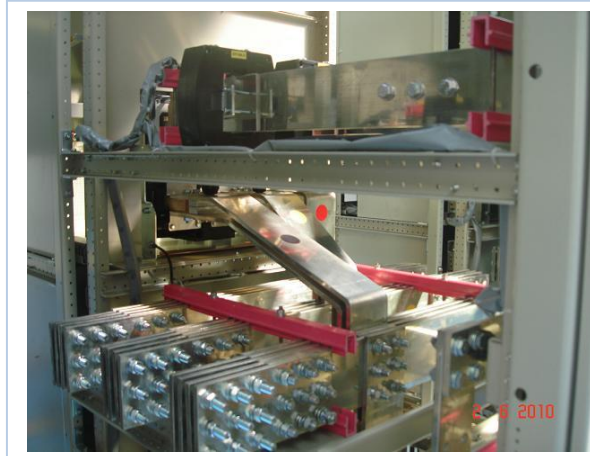



1. Motor Control Center (MCC)

✚ Medium Voltage MCC Up to 7.2kV, 3150A, 40kA



✚ Low Voltage MCC Up to 690V, 4000A, 70kA





ConocoPhillips - PT. Rekayasa Industri - GE - SUMPAL COMPRESSION Pj. (OIL & GAS)



ConocoPhillips - PT. Rekayasa Industri - GE - SUMPAL COMPRESSION Pj. (OIL & GAS)

2. Synchronizing Generator Panel



3. Capacitors Bank

✚ Medium and Low Voltage Capacitors Bank



4. HUATECH AMS 12-40.5kV Metal Clad Switchgear



AMS metal-clad switchgear is designed and manufactured with advance technology and has been comprehensively and successfully **type-tested**. AMS switchgear is typically used in power plant, substation of public utilities and suitable to provide control and protection for transformers, capacitors and motors. The rated voltage of SecoGear is 12-24kV and rated current ranges from 630A to 4000A.

VEP is designed, assembled and tested to meet or exceed applicable IEC, DIN VDE, and GB/DL standards. AMS is designed for power protection applications in all major industries, including Power Generation, T&D, Oil&Gas, Automotives, Processing Plants, and Commercial Buildings

Product Structure Drawing

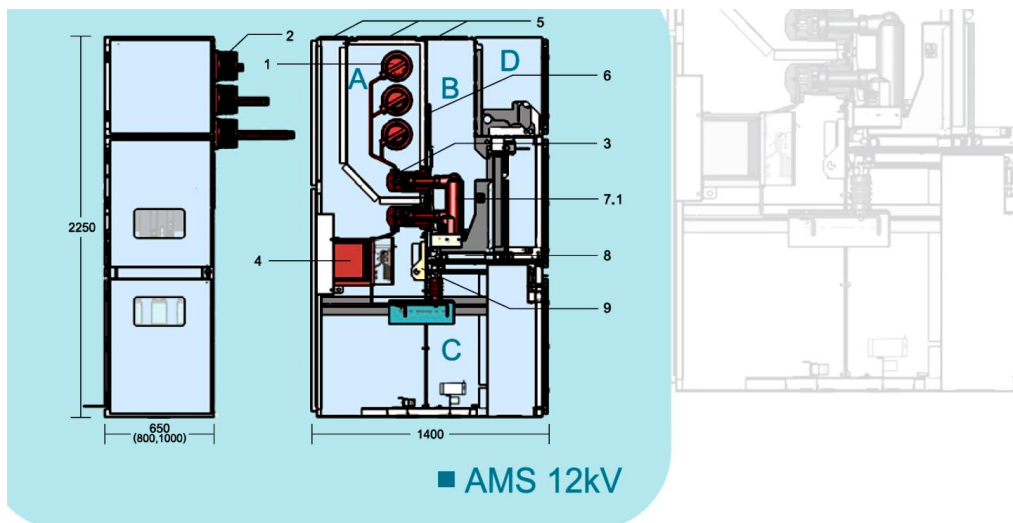

- A. Busbar Compartment
- B. Circuit Breaker Compartment
- C. Cable Compartment
- D. Low Voltage Compartment

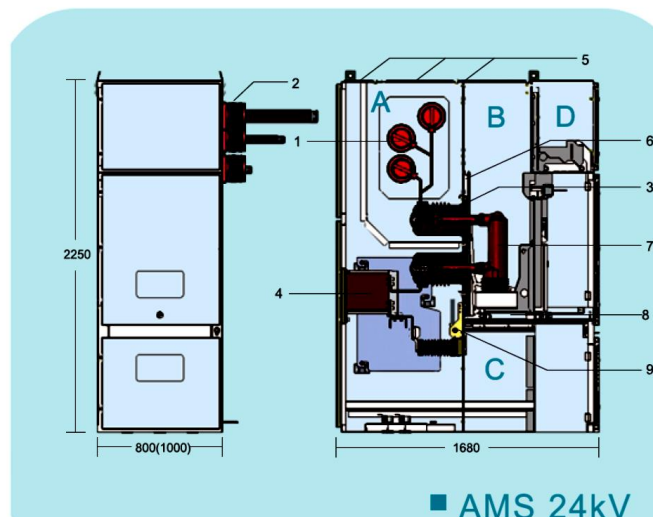

AMS Technical data

Overview of the Technical data of 12kV AMS Metal-Clad Switchgear

Description		Unit	Data
Rated voltage		kV	3.6/7.2/12/15/17.5
Rated frequency		Hz	50/60
Rated insulation level	Rated power frequency withstand voltage/1 min	kV	42
	Rated lightning impulse withstand voltage(peak value)	kV	75/95
Rated current of busbar		A	630/1250/1600/2000/2500/3150/4000*
Rated current of T-off bar		A	630/1250/1600/2000/2500/3150/4000*
Rated short time withstand current (4s)		kA	20/25/31.5/40/50
Rated peak withstand current (peak value)		kA	50/63/80/125/150
Resistance of main circuit		$\mu\Omega$	$\leq 150 + CT^{**} (\leq 630A)$ $\leq 100 + CT^{**} (\leq 1250A)$ $\leq 70 + CT^{**} (\leq 2000A)$ $\leq 50 + CT^{**} (\geq 2500A)$
Ingress Protection Degree			Enclosure IP4X, Compartment IP2X
Overall dimensions (w x h x d)		mm	650 (800, 1000) x 2250 x 1400

Note:

- * - Forced cooling ventilation is required
- ** - DC resistance of current transformer

Overview of the Technical data of 24kV AMS Metal-Clad Switchgear

Description		Unit	Data
Rated voltage		kV	24
Rated frequency		Hz	50/60
Rated Insulation level	Rated power frequency withstand voltage/1 min	kV	50/65
	Rated lightning impulse withstand voltage (peak value)	kV	125
Rated current of busbar		A	630/1250/1600/2000/2500/3150/4000*
Rated current of T-off bar		A	630/1250/1600/2000/2500/3150/4000*
Rated short time withstand current (4s)		kA	20/25/31.5/40
Rated peak withstand current (peak value)		kA	50/63/80/100
Resistance of main circuit		$\mu\Omega$	$\leq 150 + CT^{**} (\leq 630A)$ $\leq 100 + CT^{**} (\leq 1250A)$ $\leq 70 + CT^{**} (\leq 2000A)$ $\leq 50 + CT^{**} (\geq 2500A)$
Ingress Protection Degree			Enclosure IP4X, Compartment IP2X
Overall dimensions (w x h x d)		mm	800 (1000) x 2250 x 1680

Note:

- * - Forced cooling ventilation is required
- ** - DC resistance of current transformer

5. GE SecoGear 12kV



6. Smart MCC Fixed type

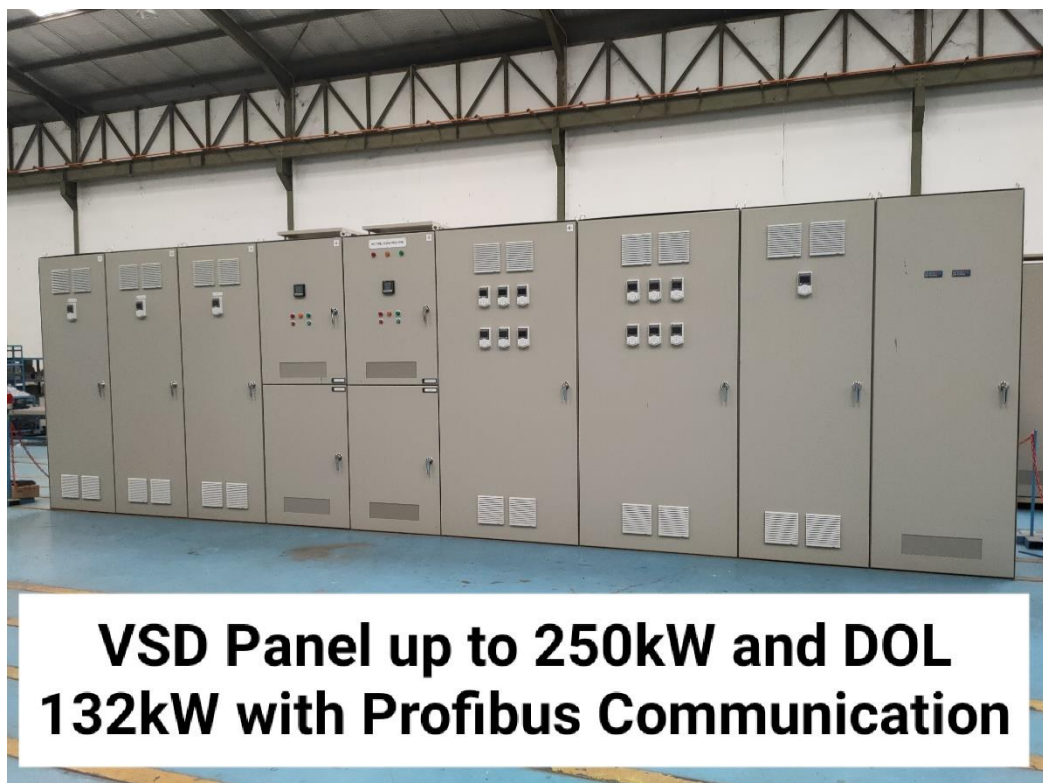

Siemens Simocode or Schneider Tesys T Motor Protection relay , with Siemens Profibus equipment

7. PLC Panel.





5. FASILITAS KAMI

PENGETESAN PANEL SEBELUM DI KIRIM KE CUSTOMER



ALAT ALAT TEST



Secondary injection 50A-3PH



MERGER / INSULATION TESTER
 VOLTAGE : 500 V
 0 ~ 1000 M ohm



HIGH VOLTAGE INSULATION TESTER /
 INSULATION VOLTAGE : 5000 V
 0 ~ 200.000 M ohm



AC / DC WITH STAND VOLTAGE TESTER
 VOLTAGE : 0 ~ 5 KV AC MAX
 VOLTAGE : 0 ~ 6 KV DC MAX



TRUE RMS CLAMP METER
VOLTAGE : 0 ~ 1000 V
CURRENT : 0 ~ 2000 A



WITH STAND HIGH VOLTAGE TEST
VOLTAGE : 0 ~ 50 KV



HIGH VOLTAGE INDICATOR
Voltage : 3 ~ 34.5KV



PHASA SEQUENCE (PHASE INDICATOR)

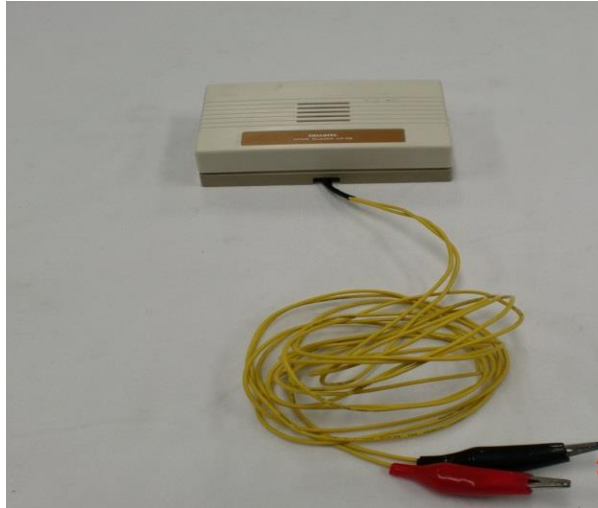

BUZZER



MULTI METER



VOLTAGE DETECTOR
Voltage : 80 ~ 4000V



AMBIEN TEMPERATUR & HUMIDITY

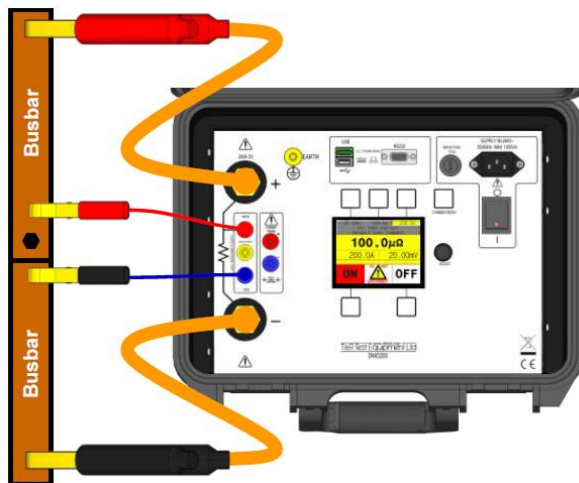

Mikro Ohm Meter (DC 200A, 0.1 mikro ohm - 5 ohm) CT/PT Analyzer



Circuit breaker Analyzer



Primary Current Single Phase Up to 3800A



Relay tester NEWPATH RTS 166

- 21 - Distance Relay
- 25 - Synchronizing Device
- 27 - Under Voltage Relay
- 32 - Directional Power Relay
- 40 - Field Relay
- 46 - Reverse Phase Current Relay
- 47 - Phase Sequence Voltage Relay
- 48 - Incomplete Sequence Relay

- 50 - Instantaneous Over-Current Relay
- 51 - Inverse Time Over-Current Relay
- 55 - Power Factor Relay
- 59 - Over Voltage Relay
- 60 - Voltage Balance Relay
- 64 - Ground Detector Relay
- 67 - Directional Over-Current Relay
- 78 - Phase Angle Out of Step Relay

- 79 - Automatic Reclosing Relay
- 81 - Frequency Relay
- 85 - Pilot Wire Receiver Relay
- 86 - Lockout Relay
- 87 - Differential Protection Relay
- 91 - Voltage Directional Relay
- 92 - Power Directional Relay
- 94 - Tripping Relay

6. REFERENSI PROYEK

No	Nama Project	Tahun	Total Qty	Rating/Type
1	GRAND HYATT HOTEL, BALI	2006	32 Columns	400VAC
2	KELAPA GADING SQUARE	2006	24 Columns	
3	MENARA PRIMA, JAKARTA	2006	64 Columns	400VAC, 3200A
4	CAMBRIDGE CONDOMINIUM, MEDAN	2007	86 Columns	400Volt LVMDP 4000A
5	CAMBRIDGE MALL, MEDAN	2007	40 Columns	400Volt LVMDP 4000A
6	HOTEL IBIS, SOLO	2007	31 Columns	400Volt LVMDP 1600A
7	MALL MATAHARI, PURI DAAN MOGOT	2007	01 Column	
8	MENARA PALMA, MEGA KUNINGAN	2007	90 Columns	400Volt LVMDP 4000A
9	SINARMAS OFFICE	2007	38 Columns	400Volt LVMDP 2500A
10	TALAVERA OFFICE PARK	2007	89 Columns	400Volt LVMDP 4000A
11	WATERPLACE	2007	06 Columns	400Volt LVMDP 4000A
12	AMBASSADE RESIDENCE	2008	04 Columns	
13	CAMBRIDGE, MEDAN	2008	06 Columns	400Volt Synchrone Genset 3 X 1000kVA 2 Sets
14	FIT OUT TALAVERA	2008	06 Columns	
15	GEREJA, PEJAGALAN	2008	15 Columns	
16	GEREJA, TAMAN SURYA	2008	01 Column	
17	HOTEL SWISS BELL, MEDAN	2008	02 Columns	400Volt LVMDP 3200A
18	HYPERMART, BALI	2008	09 Columns	
19	IKPP Perawang	2008	06 Cubicles	36KV CGIS, 630A, 31.5kA
20	LONTAR PAPYRUS PULP & PAPER INDUSTRY, JAMBI MILLS	2008	04 Cubicles	36KV CGIS, 630A, 31.5kA
21	MENARA DEA 2	2008	74 Columns	400Volt LVMDP 3200A
22	RUMAH, PEJATEN	2008	01 Column	
23	SAMPOERNA BUILDING	2008	01 Cubicle	Synchrone Genset 3,3KV; 2 X 2000kVA 2 Units Incoming Generator; 5 Units Outgoing 630A 25KA
24	TALAVERA AEL	2008	02 Columns	
25	TALAVERA HENKEL	2008	03 Columns	
26	TALAVERA MADANI	2008	02 Columns	
27	TALAVERA ULUWATU	2008	01 Column	
28	TALAVERA WEATHER FORD	2008	05 Columns	
29	TIARA MARGA TRAKINDO	2008	49 Columns	
30	CAMBRIDGE HOTEL- MEDAN	2009	01 Column	SYNCHRONIZING GENSET PLN
31	CAMBRIDGE MALL- MEDAN	2009	01 Column	SYNCHRONIZING GENSET PLN
32	HOTEL OASIS, BALI	2009	22 Columns	
33	THE HEAVEN, BALI	2009	55 Columns	
34	UNIVERSITAS BUNDA MULIA 2	2009	38 Columns	
35	ANCOL MANSION	2010	01 Column	
36	ANJ-RENT	2010	03 Columns; 01 Columns; 05 Columns; 15 Sets	400Volt ACB Panel 1250A; 400Volt Capacitor Bank 300 KVAR; 400Volt FS Panel; 400Volt WM Panel
37	ASPEX KUMBONG	2010	04 Cubicle	6.6KV Capacitors Bank 1000KVAR

No	Nama Project	Tahun	Total Qty	Rating/Type
38	EKA HOSPITAL - PEKANBARU	2010	05 Columns; 02 Columns; 18 Columns; 37 Sets	400Volt ACB Panel 1600A; 400Volt Capacitor Bank 300 KVAR; 400Volt FS Panel; 400Volt WM Panel
39	EKA HOSPITAL BSD-TANGERANG	2010	01 Column; 02 Sets	400Volt FS Panel; 400Volt WM Panel
40	FAJAR PAPER (FSW)PM-5	2010	14 Cubicles 08 Cubicles28 Cubicles05 Columns16 Columns 144 Columns	20KV SWITCHGEAR 25KA, 1250A; type tested. 3KV SWITCHGEAR; 3KV MCC SWITCHGEAR (Up To 1100KW); MCC UTILITY; LV SWITCHGEAR 5000A/2500A; LV MCC DRAWOUT SEN PLUS (Up To 200KW INVERTER).
41	FAJAR PAPER (FSW) PM-5	2010	02 Columns	Panel Inverter 1.5KW
42	FAJAR PAPER (FSW) INCENERATOR #2	2010	02 Cubicles 05 Cubicles 04 Columns 03 Columns 13 Columns	20KV SWITCHGEAR 25KA, 1250A; type tested. 3KV SWITCHGEAR; 380V SWITCHGEAR; CAPACITOR BANK 1200KVAR; LV MCC DRAWOUT SENPLUS (Up To 132KW INVERTER).
43	GEDUNG CNI	2010	01 Column	
44	HOTEL AMARIS JOGJA	2010	32 Columns	400Volt LVMDP 400A
45	HOTEL NOVOTEL, LAMPUNG	2010	62 Columns	
46				
47	IKPP Serang PM-A	2010	01 Column	3.3 KV MDP
48	TIARA MARGA TRAKINDO	2010	23 Columns	
49	VIHARA PLUIT	2010	01 Set	400Volt WM Panel
50	BIBLE CENTER-SALEMBA	2011	10 Sets	400Volt D/P Panel
51	FAJAR PAPER (FSW) 150KV SUBSTATION	2011	06 Cubicles	20KV SWITCHGEAR 25KA, 2000A; type tested.
52	FAJAR PAPER (FSW) PM#7 (ADITIONAL)	2011	04 Cubicles 04 Columns 03 Columns 48 Columns	3.3KV MCC Panel 2000 A (3 TIER 400 KW); 400Volt ACB Panel 5000A; 400Volt Capacitor Bank 600 KVAR; 400Volt MCC Panel 2000 A
53	GAS TURBIN POWER PLANT, BORANG	2011	09 Columns; 06 Sets; 01 Sets	400Volt FS Panel; 400Volt WM Panel; 110Volt WM Panel
54	LONTAR POPYRUS PULP & PAPER INDUSTRY, JAMBI MILLS	2011	08 Cubicles	3.3kv SWITCHGEAR 1600 A
55	MAX ONE HOTEL SABANG - JAKARTA	2011	22 Columns	400Volt LVMDP 630A
56	NOVOTEL HAYAM WURUK	2011	18 Columns 04 Columns 29 Columns 76 Sets	400Volt ACB Panel 4000A; 400Volt Capacitor Bank 700KVAR; 400Volt FS Panel; 400Volt WM Panel
57	OFFICE SURABAYA	2011	46 Columns	
58	PT. MKM. I – PULO GADUNG	2011	05 Columns	400Volt D/P Panel

No	Nama Project	Tahun	Total Qty	Rating/Type
59	SAINT NICHOLAS SCHOOL	2011	01 Set	400Volt Panel ATS / AMF
60	SYNCHRUM LOGISTIC	2011	01 Column; 06 Columns; 17 Sets	400Volt Capacitor Bank 150 KVAR; 400Volt FS Panel; 400Volt WM Panel
61	BEST WESTERN HOTEL-BALI	2012	05 Columns; 02 Columns; 10 Columns; 22 Sets	400Volt ACB Panel 2000A; 400Volt Capacitor Bank 550 KVAR; 400Volt FS Panel; 400Volt WM Panel
62	BINTARO EXCHANGE	2012	08 Columns	400Volt Synchrone Genset 4 X 2000kVA
63	FAJAR PAPER (FSW) PM#1 NDLKC	2012	03 Cubicles	20KV SWITCHGEAR 25KA, 2000A; type tested.
64	FAJAR PAPER (FSW) PM#1 PC-13	2012	02 Cubicles	20KV SWITCHGEAR 25KA, 2000A; type tested.
65	FAJAR PAPER (FSW)PM-5	2012	03 Cubicles;03 Cubicles	20KV SWITCHGEAR 25KA, 2000A; type tested.
66	FAJAR PAPER (FSW) GT-1 SYNCHRONE	2012	04 Cubicles	20KV SWITCHGEAR 25KA, 2000A;type tested.
67	FAJAR PAPER (FSW) GT-1 SYNCHRONE	2012	02 Cubicles	20KV SWITCHGEAR 25KA, 1250A; type tested.
68	GUNUNG MEGANG ADD ON 30MW - SUMSEL	2012	06 Columns; 06 Columns; 08 Sets	400Volts MCC (D/O Type); 400Volt FS Panel; 400Volt WM Panel
69	HOTEL CILOTO-PUNCAK	2012	02 Columns; 01 Columns; 03 Columns; 07 Sets	400Volt MCCB Panel 200A; 400Volt Capacitor Bank 50 KVAR; 400Volt FS Panel; 400Volt WM Panel
70	HOTEL SANTIKA - PURWOKERTO	2012	03 Columns; 02 Columns; 01 Column; 08 Columns; 22 Sets	400Volt MCCB Panel 630A; 400Volt PKG ACB Panel 1000A; 400Volt Capacitor Bank 300 KVAR; 400Volt FS Panel; 400Volt WM Panel
71	LONTAR POPYRUS PULP & PAPER INDUSTRY, JAMBI MILLS	2012	08 Columns	400Volt MCC Fixed Type
72	MENARA PRIMA II	2012	11 Columns 05Columns 04 Columns; 46 Columns; 312 Sets	400Volt ACB Panel 4000A; 400Volt SYNCHRONE Genset (2X1275kVA) + (1X1000kVA) ; 400Volt Capacitor Bank 1100 KVAR; 400Volt FS Panel; 400Volt WM Panel
73	PT. SOLID ENERGY - Pertamina NIRU LIMAU	2012	07 Columns; 09 Columns; 08 Columns	400Volts MCC 6400A ; 400Volts MCC 2500A; 400Volts MCC 1200A
74	PT. PABRIK KERTAS TJIWI KIMIA	2012	02 Columns; 03 Columns;	400Volt ACB Panel 3200 A; 400Volt Capacitor Bank 600 KVAR
75	PT. PABRIK KERTAS TJIWI KIMIA	2012	02 Columns	Inverter Panel 160KW Dan 132KW
76	CIBINONG CITY MALL	2013	23 Columns; 05 Columns; 04 Columns; 46 Columns; 312 Sets	400Volt ACB Panel 4000A; 400Volt PKG Panel 4000A; 400Volt Capacitor Bank 1950 KVAR; 400Volt FS Panel; 400Volt WM Panel

No	Nama Project	Tahun	Total Qty	Rating/Type
77	FAJAR PAPER (FSW) MDP DRIVE PM#3	2013	01 Columns	400Volt ACB Panel 5000A
78	IKPP Serang GCC	2013	03 Cubicles; 06 Cubicles;	20KV SWITCHGEAR 25KA, 1250A; type tested. 3.3KV SWITCHGEAR Panel 3150A
79	HOTEL IBIS SENEN - JKT	2013	05 Columns; 02 Columns; 01 Column; 11 Columns; 19 Sets	400Volt MCCB Panel 630A; 400Volt PKG ACB PanelL 1000A; 400Volt Capacitor Bank 300 KVAR; 400Volt FS Panel; 400Volt WM Panel
80	HOTEL IBIS SERPONG	2013	04 Columns; 01 Column; 25 Sets	400Volt ACB Panel 1250A; 400Volt Capacitor Bank 275 KVAR; 400Volt WM Panel
81	HOTEL RANCAMAYA BOGOR	2013	09 Columns; 02 Columns; 05 Columns; 21 Sets	400Volt ACB Panel 2000A; 400Volt Capacitor Bank 600 KVAR; 400Volt FS Panel; 400Volt WM Panel
82	IKPP Perawang 3.3KV TG-1 60Hz RECONDITION	2013	08 Cubicles; 01Cubicle;	3.3KV SWITCHGEAR 40KA, 3150A;type tested. SUPERVISORY PANEL (RELAY PANEL)
83	KANTOR MDPU	2013	04 Columns01 Column 04 Columns22 Sets	400Volt MCCB PANEL 1000A 400Volt Capacitor Bank 300 KVAR; 400Volt FS Panel; 400Volt WM Panel
84	LANDMARK PLUIT	2013	05 Columns 02 Columns; 27 Columns; 119 Sets	400Volt ACB PANEL 200A 400Volt Capacitor Bank 500KVAR; 400Volt FS Panel; 400Volt WM Panel
85	PABRIK KERAMIK NGORO – MOJOKERTO 20KV	2013	05 Cubicles; 16 Cubicles	20KV SWITCHGEAR 25KA, 1250A; type tested. 20KV SWITCHGEAR 25KA, 630A; type tested.
86	PABRIK KERAMIK NGORO – MOJOKERTO 400V	2013	34 Columns; 07 Columns; 15 Columns; 17 Sets	400Volt ACB Panel Up To 3200A; 400Volt Capacitor Bank 600 KVAR; 400Volt FS Panel; 400Volt WM Panel
87	PALMA TOWER,	2013	04 Columns	400Volt PKG ACB Panel 4000A 400V Synchrone Genset 2X2000KVA
88	PT. WIJAYA KARYA; PLTG PEAKING - KALTIM	2013	26 Columns	400Volts MCC Fixed 5000A ACB Incoming
89	SUMPAL EXPANSION PROJECT	2013	03 Sets	600Volts WM Panel
90	TALAVERA SUITE	2013	07 Columns; 02 Columns; 37 Columns; 231 Sets	400Volt ACB Panel 4000A; 400Volt Capacitor Bank 1000KVAR; 400Volt FS Panel; 400Volt WM Panel
91	GREEN FIELD BREWERY ORANG TUA SEMARANG	2014	07 Columns; 15 Columns; 10 Columns; 06 Sets	400Volt Capacitor Bank 1325KVAR; 400Volt ACB Panel Up To 4000A; 400Volt FS Panel; 400Volt WM Panel

No	Nama Project	Tahun	Total Qty	Rating/Type
92	HOLIDAY IN EXPRESS BALI	2014	01 Column; 05 Columns; 10 Columns; 45 Sets	400Volt Capacitor Bank 1325KVAR; 400Volt ACB Panel Up To 1600A; 400Volt FS Panel; 400Volt WM Panel
93	KERTAS KRAFF ACEH - PLN	2014	08 Cubicles; 02 Cubicles	20KV SWITCHGEAR 25KA, 1250A; type tested. 6.6kV Metal Enclosed 40kA/1sec
94	LONTAR POPYRUS PULP & PAPER INDUSTRY, JAMBI MILLS	2014	03 Columns	690V Fixed type MCC
95	MENARA PALMA 2	2014	21 Columns 9 Columns 6 Columns 54 Columns 251 Columns;	400Volt ACB Panel Up To 4000A 400Volt Capacitor Bank 8000KVAR; 400Volt SYN GENSET 3X 2000KVA; 400Volt FS Panel; 400Volt WM Panel
96	IKPP Perawang DISTIBUSI PANEL EMERGENCY 380V	2014	03 Columns	400Volt ACB Panel Up To 4000KW
97	PT. PALM SEMESTA, ASPEX KUMBONG	2014	17 Columns	400Volt Inverter Panel Up To 250KW
98	STADION BOGOR	2014	14 Columns; 08 Columns; 10 Sets	400Volt ACB Panel Up To 1250A; 400Volt FS Panel; 400Volt WM Panel
99	GRAND MERCURE - KEMAYORAN	2015	04 Columns 01 Column; 10 Columns; 45 Sets	400V Synchrone Genset 2X 2000KVA; 400Volt Capacitor Bank 1325KVAR; 400Volt FS Panel; 400Volt WM Panel
100	HOTEL RESINDA-KARAWANG	2015	02 Columns; 03 Columns	400Volt Capacitor Bank 4000KVAR; 400Volt ACB Panel Up To 2000A;
101	MALL RESINDA	2015	07 Columns 01 Columns 23 Columns 12 Columns 56 Columns 81 Columns 13 Columns	400V SYNCHROME Genset 3X 2000KVA 400V PKG ACB Panel 2500A400V ACB PANEL Up To 4000A 400V Capacitor Bank 3200KVAR 400V FS Panel400V WM Panel Inverter Panel Up To 75KW (CH)
102	LAUTAN OTSUKA	2015	01 Column 01 Column 01 Column	Panel Inverter 110KW; Panel Inverter 45KW; Panel Inverter 7,5KW
103	MENARA PERTIWI	2015	06 Columns; 17 Columns; 29 Columns; 39 Sets	400Volt Capacitor Bank 1000KVAR; 400Volt ACB Panel Up To 4000A; 400Volt FS Panel; 400Volt WM Panel
104	FAJAR PAPER (FSW)	2015	04 Sets	Desk Control
105	PT. OKI PULP & PAPER - PALEMBANG	2015	03 Columns; 03 Columns; 03 Columns 02 unit	11KV Switchgear MCC Lokal; MCC Lokal GE Dry Transformer 315/630kVA
106	RS DR.OEN - SURAKARTA	2015	06 Columns; 17 Columns; 29 Columns; 39 Sets	400Volt Capacitor Bank 1000KVAR; 400Volt ACB Panel Up To 3200A; 400Volt FS Panel; 400Volt WM Panel

No	Nama Project	Tahun	Total Qty	Rating/Type
107	SUMPAL COMPRESSION	2015	10 Columns; 08 Columns 08 Columns 09 Columns	400V Normal SWGR (82 ZEN-004); 400V Normal MCC-F (82 ZEN-005A); 400V Normal MCC-G (82 ZEN-005B); 400V Emergency MCC-H (84 ZEN-006)
108	SWISS-BEL HOTEL JOGJAKARTA	2015	06 Columns; 04 Columns; 32 Sets	400Volt ACB Panel; 400Volt FS Panel; 400Volt WM Panel
109	TMEIC ASIA INDONESIA Project In THAILAND	2015	06 Sets	Desk Control Panel
110	FAJAR PAPER (FSW) PM#8	2016	19 Columns 08 Columns; 24 Columns; 08 Columns; 75 Columns; 62 Columns; 40 Columns; 09 Columns; 15 Columns; 08 Columns; 24 Columns; 06 Columns; 56 Sets	20KV SWITCHGEAR 31.5KA, up to 2500A; type tested. MDB 3KV Up To 2000A; MCC 3KV Up To 1300KW; Capacitor Bank 3KV Up To 319KVAR; MCC Drawout Up To 75KW; MCC Fix S/S Up To 200KW; MCC Fix Inv. Up To 315KW; MDB 5000A; MDB 2500A; Capacitor Bank 1600 KVAR; MCC Fix; 380Volt FS Panel; 380Volt WM Panel
111	GRAMEDIA, KARAWANG	2016	06 Sets	400Volt WM Panel
112	HOTEL AMARIS MAMPANG	2016	07 Columns; 25 Columns;	400Volt FS Panel 400Volt WM Panel
113	HOTEL NOVOTEL, LAMPUNG	2016	01 Columns; 09 Sets	400Volt FS Panel 400Volt WM Panel
114	HOTEL GAIA BANDUNG	2016	09 Columns; 01 Columns; 03 Columns 108 Sets.	400Volt ACB Panel Up to 2000A; 400Volt Capacitor Bank 500KVAR; 400Volt FS Panel; 400Volt WM Panel.
115	HOTEL SANTIKA BELITUNG	2016	06 Columns; 01 Columns; 02 Columns; 31 Sets.	400Volt ACB Panel Up to 1250A; 400Volt Capacitor Bank 500KVAR; 400Volt FS Panel; 400Volt WM Panel.
116	THE MANHATTAN MALL, MEDAN	2016	18 Columns; 08 Columns; 05 Columns; 24 Columns; 75 Sets.	400Volt ACB Panel Up to 3200A;400Volt Inverter Up to 55KW;400Volt Capacitor Bank 800KVAR;400Volt FS Panel;400Volt WM Panel.
117	FAJAR PAPER (FSW) PM#1	2016	03 Columns.	MCC 3KV Up to 1300KW
118	FAJAR PAPER (FSW) CORE BOX	2016	10 Columns; 11 Columns	MDP 5000A; 400Volt FS Panel;
119	FAJAR PAPER (FSW) MCC 5 SP1, SP2	2017	04 Columns; 09 Columns	400Volt ACB Panel Up to 5000A; MCC Modular Fix Up to 1600A;
120	FAJAR PAPER (FSW) PM#1	2017	04 Columns	20KV SWITCHGEAR 25KA, 1250A; type tested. MDB PM#1 5000A
121	PT. PINDO DELI PULP & PAPER - KARAWANG	2017	02 Columns	400Volt D/P Panel

No	Nama Project	Tahun	Total Qty	Rating/Type
122	FAJAR PAPER (FSW) DRUM PULPER PM#8	2017	04 Columns	3.3kV STARTING REACTOR
123	PT. PINDO DELI PULP & PAPER - KARAWANG	2017	05 Columns	400Volt MCC Modular Fixed type
124	HOTEL IBIS, PALEMBANG	2017	06 Columns; 01 Columns	400Volt ACB Panel; 400Volt Capacitor Bank 375KVAR;
125	PT. PINDO DELI PULP & PAPER - PERAWANG, TISSUE	2017	06 Columns	400Volt D/P Panel
126	IKPP Perawang PLN - BUNUT	2017	08 Cubicles;	3,3/12KV SWITCHGEAR 25KA, 3150A; type tested.
127	IKPP Perawang UPGRADE MOTOR AERATOR TRITON AT-EN9	2017	14 Columns	400Volt MCC Modular Fixed type 1600A
128	IKPP Tangerang,	2017	03 Columns	400Volt DISTRIBUTION PANEL AC- DRIVE 4000A
129	PTC - PALEMBANG	2017	01 Columns; 06 Columns 03 Columns; 04 Columns; 03 Columns; 15 Columns	400Volt PKG 2000kVA ; 3200A; 400Volt LVMDP 3200A; 400Volt CAP. 1000KVAR; 400Volt MDP ACB 2000A; 400Volt FS Panel; 400Volt WM Panel
130	PT. PABRIK KERTAS TJIWI KIMIA	2018	08 Cubicles;	3,3KV SWGR 1250A
131	FAJAR PAPER (FSW) PM#1	2018	03 Cubicles;	20KV SWITCHGEAR 25KA, 1250A; type tested.
132	My Pack	2018	06 Columns;	400Volt CAP. 1600KVAR
133	HOTEL MERCURE - BOJONEGORO	2018	05 Columns; 03 Columns; 26 Columns	400Volt ACB PUTR 1250A & CAP. 800A; 400Volt FS Panel; 400Volt WM Panel
134	MARGO CITY - DEPOK	2018		400Volt CAP. 1600KVAR
135	HOTEL SHERATON - BELITUNG	2018		400Volt CAP. 1600KVAR
136	RUMAH SAKIT PRICILLA - CILACAP	2018	03 Columns; 05 Columns; 02 Columns; 08 Columns; 28 Columns	400Volt Panel Kontrol Genset 1000A 400Volt ACB/LVMDP 2000A 400Volt CAP 1000A 400Volt FS Panel 400Volt WM Panel
137	FAJAR PAPER (FSW)	2018	01 Columns	400Volt P-MDB 5000A
138	FAJAR PAPER (FSW)	2018	01 Columns	400Volt ACB Panel 1600A
139	GRHA SPT SERPONG	2018	02 Columns; 05 Columns; 02 Columns; 02 Columns; 20 Columns	400Volt Panel Kontrol Genset 800A 400Volt ACB / PUTR 1600A 400Volt CAP. 1250A 400Volt ACB / FS Panel 400Volt WM Panel
140	HOTEL KRYIAD - SUMBA	2019	03 Columns; 02 Columns; 01 Columns; 19 Columns	400Volt ACB 1250A 400Volt CAP. 1000A 400Volt FS Panel 400Volt WM Panel

No	Nama Project	Tahun	Total Qty	Rating/Type
141	FAJAR PAPER (FSW) DRUM PULPER	2019	05 Columns; 05 Columns; 01 Columns; 07 Columns; 03 Columns; 31 Columns; 15 Columns	3,3 KV VCB 1250A SP 1/2 3,3 KV SP 3/7 3,3 KV VCB 3150A SP 3/7 380V MDP 2500A 380V CAP. 1200KVAR 380V FS PANEL 380V WM PANEL
142	HELIPAD - RESINDA KARAWANG	2019	05 Columns; 05 Columns; 01 Columns;	400Volt PKG PUTR & CAP. 1000A 400Volt FS Panel 400Volt WM Panel
143	GRAND MERCURE - KEMAYORAN	2019	06 Columns; 116 Columns	400Volt FS Panel 400Volt WM Panel
144	FAJAR PAPER (FSW) DCS AUTOMATION	2019	17 Columns	400Volt MCC Modular Fixed type
145	IKPP Perawang ATS PANEL & MCC PANEL	2019	13 Columns	400Volt MCC Modular Fixed type
146	TMEIC ASIA INDONESIA DAYASA	2019	03 Columns	400 Volt ACB Panel 2500A
147	FAJAR PAPER (FSW)	2019	01 Columns	400 Volt ACB Terasaki
148	FAJAR PAPER (FSW) PANEL INSTRUMENT PM#2	2019	01 Columns	400Volt MCC Modular Fixed type
149	PT. Dayasa Aria Prima PM#1/2/3/5	2019	3 Panel 2 Panel 65 Columns	6 KV Switchgear 6 KV MCC 1000KW & 630KW 400V, MCC Modular Fixed Type
150	MALL ALAM SUTRA - PT. INDOMEKO	2019	08 Columns	400 Volt WM Panel
151	IKPP Perawang, RETROFIT	2019	07 Columns	400 Volt ACB Panel 3200A & 1600A
152	TMEIC ASIA INDONESIA NIPPON SHOKUBAI INDONESIA	2019	01 Columns	400 Volt / 6KV BUSDUCT CHECKING
153	FAJAR PAPER (FSW)	2019	01 Columns	400 Volt STAR DELTA 2 X 110 KW
154	J&T CIRACAS	2019	06 Cubicals 13 Cubicals	400 Volt FS Panel 400 Volt WM Panel
155	IKPP Serang UPGRADE PANEL ACB MCC-6 DAN MCC -3	2019	02 Columns	400 Volt, 4000A
156	IKPP Perawang Cationic	2019	18 Columns	400Volt MCC Modular Fixed type
157	PT. OKI PULP & PAPER - PALEMBANG	2019	06 Columns	400Volt MCC Modular Fixed type
158	Pasific Garden Apartment - Alam Sutra	2019	23 Columns 56 Panel	400V, PDTR dll Wall Mounting
159	PT. OKI PULP & PAPER - PALEMBANG	2019	05 Columns 11 Panel	400Volt MCC Modular Fixed type 380V, WM Panel
160	PT. Dayasa Aria Prima	2020	07 COLUMNS	6KV MCC 500KW & 220KW
161	FAJAR PAPER (FSW)	2020	07 COLUMNS 09 COLUMNS 08 COLUMNS	380V, MDB & MCC Modular Fixed type 380V, MCC Panel 380V, MCC Panel
163	FAJAR PAPER (FSW) Power Instrument Drum Pulper	2020	09 Panel	

No	Nama Project	Tahun	Total Qty	Rating/Type
164	Apartment Pacific Garden	2020	06 Columns 05 Panel	400Volt Synchron Genset 3X1250 kVA 400V, WM Panel
165	FAJAR PAPER (FSW) Side Hill Screen	2020	07 Columns	400Volt MCC Modular Fixed type
166	FAJAR PAPER (FSW) Screw Press WWT	2020	09 Columns	400Volt MCC Modular Fixed type
167	FAJAR PAPER (FSW) DAF Modification	2020	08 Columns	400Volt MCC Modular Fixed type
168	ITB BANDUNG	2020	03 Columns 18 Panel	380V, PDTR & FS Panel 380V, WM Panel
169	HOTEL KAMBANIRU SUMBA	2020	06 Columns 17 Panel	380V, PDTR & FS Panel 380V, WM Panel
170	IKPP Tangerang,	2020	01 Columns	3,3kV, MCC 300kW Reactor Starting
171	PT. PINDO DELI PULP & PAPER - KARAWANG	2020	-	RETROFIT ACB 4000A & 2500a
172	PASAR IKAN PAPUA	2020	06 Columns 15 Panel	380V, PDTR & CAP. BANK 9,2 Kvar 380V, WM Panel
173	JHL GALERY GADING SERPONG	2020	49 Panel	380V, FS & WM Panel
174	FAJAR PAPER (FSW)	2020	01 Panel	380V, WM Panel
175	APARTEMENT PACIFIC GARDEN STYLE	2020	15 Panel	380V, FS & WM Panel
176	HOTEL AYOLA ELSOTEL	2020	05 Columns 15 Panel	380V, ATS/AMF, LVMDP, CAP. BANK 225kVAR 380V, WM Panel
177	APARTEMENT ASPENA RESIDENCE TANGERANG	2020	08 Columns 13 Columns 14 Columns	380V, PUTR & CAP.BANK 900kVAR 380V, FS Panel 380V, WM Panel
178	HOTEL ARUS SEMARANG	2020	09 Columns 05 Columns 43 Columns	380V, LVMDP & CAP.BANK 800kVAR 380V, FS Panel 380V, WM Panel
179	OFFICE & SHOWROOM DAAN MOGOT	2020	07 Columns 03 Columns 27 Columns	380V, CPGS,PUTR & CAP.BANK 500kVAR 380V, FS Panel 380V, WM Panel
180	APARTEMENT PACIFIC GARDEN STYLE	2020	01 Column 05 Columns	380V, FS Panel 380V, WM Panel
181	PT. THE UNIVENUS - SERANG	2021	02 columns	380V, Distribution Panel
182	PT. PINDO DELI PULP & PAPER - KARAWANG LOCAL STARTER PANEL FOR OSBL PROJECT	2021	02 Columns	380V, Soft Starter 200kW
183	GDC SALES GALLERY IWUL PARUNG	2021	01 Column 04 Panel	380V, PUTR & CAP.BANK 10kVAR 380V, WM Panel
184	IKPP Perawang MCC PANEL SCEW PRESS PPM6	2021	09 Columns	Smart MCC Fixed Type 400Volt MCC VSD 250kW, DOL 132kW with Profibus Communication
185	IKPP Perawang PPM4 & 9 LOCC LINE	2021	09 Columns 23 Columns	3,3/12KV, SWITCHGEAR 40KA, 2000A; type tested. 400Volt MCC Modular Fixed type

No	Nama Project	Tahun	Total Qty	Rating/Type
186	Santika Premier Padang	2021	10 Columns 09 Columns 55 Panel	380V, LVMSB & CAP.BANK 700kVAR 380V FS Panel 380V, WM Panel
187	Santika Premier Padang	2021	03 Columns 2 Panel	380Volt Synchrone Genset 2X700 kVA 380V WM Panel
188	Novotel Hotel Kulon Progo	2021	2 Columns 12 Panel	400V, Panel Starter (Plumbing)
189	Electrical Power, Pindo Deli Karawang	2021	1 Panel	400V Soft Starter 200kW
190	Mayapada Chung-Chung Surabaya	2021	10 Columns 4 Columns 33 Panel	400Volt Switchgear
191	Mal Seraya Pekanbaru	2021	1 Panel	Panel Desk Proface Touchscreen
192	OKI Palembang, NPK Fertilizer Plant	2021	2 Panel 4 Columns	11kV Switchgear 1250A 400Volt MCC Modular Fixed type
193	BPR Syariah Madani- Bekasi	2021	1 Columns 6 Panel	400Volt Switchgear
194	RDMPT- Local Control	2021	80 Panel	400Volt Switchgear / VSD
195	Indah Kiat - Serang Panel Switchgear for Drum Pulper SPA	2021	6 Columns 14 Columns	3.3kV Switchgear 2000A, 25kA 400Volt MCC Drawout type
196	Indah Kiat - Serang Panel Switchgear for Drum Pulper SPB	2021	2 Columns 12 Columns	3.3kV Switchgear 3150A, 40kA 400Volt MCC Drawout type
197	Indah Kiat - Serang Panel for EGSB	2021	3 Columns	400Volt MCC Modular Fixed type
198	New East 2 Marketing Galery JGC- Cakung Clincing	2021	3 Columns 5 Columns	400Volt Switchgear
199	TMAS - IKPP Serang PM5 ABB CPE	2021		DC Busbar 4000A
200	PT. Ikanindo - VITTORIO	2022		400Volt Switchgear

Note:

1. FS Panel stand for *Free Standing* Electrical Switchboard type.
2. WM Panel stand for *Wall Mounting* Electrical Switchboard type.



MENARA PALMA 2
JI. HR. RASUNA SAID, KUNINGAN, JAKARTA





Your Trusted Professional Partner



Medium and
Low Voltage
Swictgear



Medium and
Low Voltage
MCC



Medium and
Low Voltage
Capacitor Bank



ATS and
Synchronized
Genset Panel

Office and Workshop :

Jl. Veteran No.18, Kp. Cisereh
RT 002 RW 06 Ds. Kadujaya
Kec. Curug, Kab. Tangerang 15810
Telp. : 021-5983497, 5983498
Facs. : 021-5983496
Email : mprima@centrin.net.id
Cetakan Edisi: In 20220208